

BKT
mobiliario
urbano

Ficha Técnica
Product Sheet

BAN-006

Banca Bench



La alta capacidad de configuración de este producto ofrece opciones que abarcan la elección de ciertos elementos. Esto permite adaptarse a una amplia gama de requisitos específicos del cliente, la ciudad y el usuario.

The high configurability of this product offers options covering the choice of certain elements. This makes it possible to adapt to a wide range of customer, city and user specific requirements.

Tipología
Typology

Dimensiones
Size

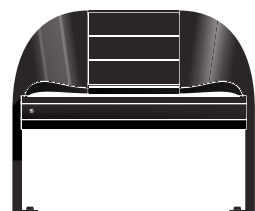

Chica

96 / 67 / 79 cm
38 / 26 / 31 in



Grande

211 / 67 / 79 cm
83 / 26 / 31 in

BAN-006



Banca Bench

Nuestra BAN-006 es una solución duradera para entornos públicos, que con su diseño curvilíneo único y una construcción de aluminio fundido, otorga propiedades de resistencia y a su vez agrega sofisticación y comodidad a cualquier espacio exterior.

Our BAN-006 is a durable seating solution for public areas, with a unique curvilinear design and cast aluminum construction, it adds resistance properties, and develops sophistication and comfort to any outdoor space as well.

Peso (Chica):37 kg

(Grande):58 kg

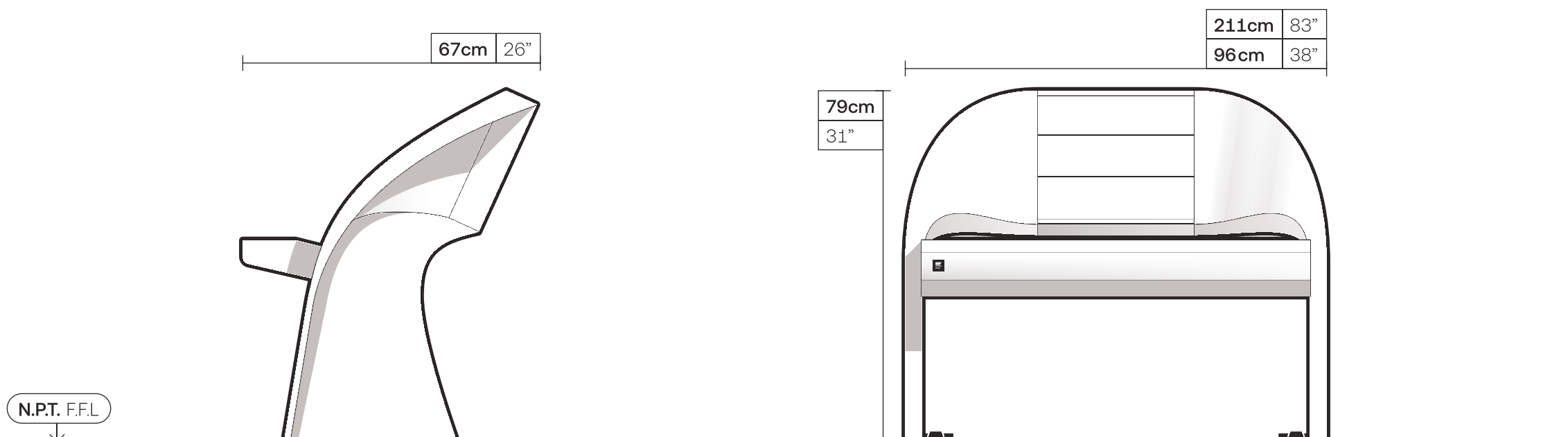

Apariencia Appearance

Cuerpo Body

- **Aluminio Fundido** Cast Aluminum

Largueros Beams

- **Madera Tropical** Tropical Wood

Configuraciones Settings

Tamaños Sizes

- **Chico** Small
- **Grande** Large

Instalación Installation

- **Taqueteable** Fastened

Para más información sobre las garantías, encuentralas en nuestro sitio web.

For more information about the warranties, find them on our website.

Garantías

Guarantees



Zona Urbana

Urban Area

Se refiere a zonas de baja polución, secas y frías, de baja humedad o algunas zonas desérticas.

It refers to areas of low pollution, dry and cold, low humidity or some desert areas.



Brisa Marina

Sea Breeze

Se refiere a embarcaderos o malecones con brisa de un grado muy alto de salinidad y neblina marina.

It refers to piers or promenades with very high levels of salt fog.



Alta Humedad

High Humidity



Se refiere a zonas húmedas sin niebla salina o con grado medio de salinidad con cercanía a la costa.

It refers to humid areas without salt fog or with a medium degree of salinity close to the coast.

Aluminio Fundido

Cast Aluminum





 60 meses months
 24 meses months



Maderas

Woods

 60 meses months
 60 meses months
 36 meses months



 [bkt_mobiliario.urbano](https://www.instagram.com/bkt_mobiliario.urbano)

[bktmobiliario.com](https://www.bktmobiliario.com)

 Herrera y Cairo 980
Col. Jesús 44200
Guadalajara, Jal. MX

 MiBici GDL-10
 L1, Estación Refugio

 +52 33 3825 7333
+52 33 3165 8582

 info@bktmobiliario.com